

DWG NO: HT1231-CUST

NOTES:

1 MATERIAL: NYLON
FDA 21 CFR 177.1500
RoHS COMPLIANT
COLOR: BLACK

2 ALL DIMENSIONS ARE TYPICAL

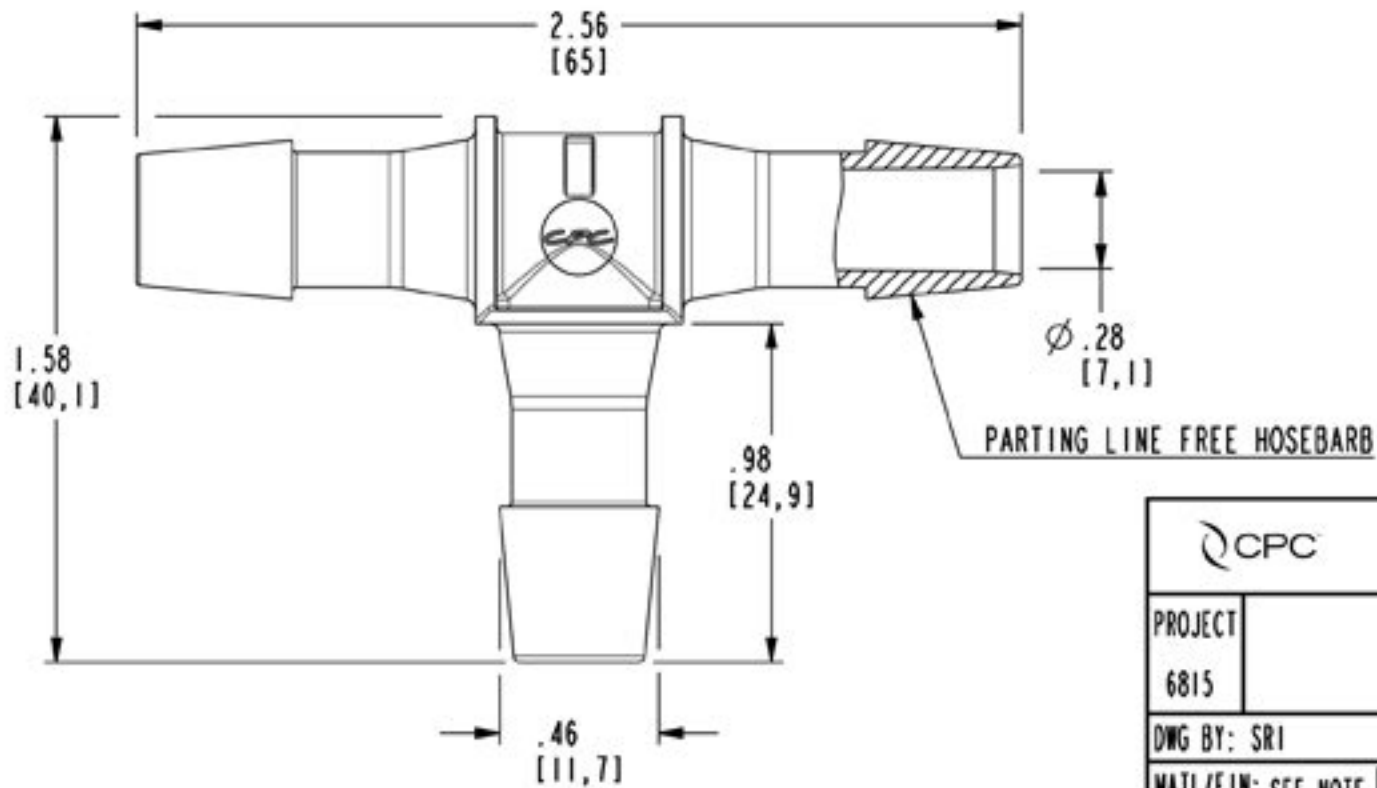

1 800 444 2474

cpcworldwide.com

PROJECT
6815

3/8 HB TEE UNION
(CUSTOMER DRAWING)

DWG BY: SR1

DATE: 06-23-09

CHKD BY:

MATL/FIN: SEE NOTE 1

DWG NO: HT1231-CUST