

DWG NO: HY5-CUST

NOTES:

1 MATERIAL: POLYPROPYLENE
FDA 21 CFR 177.1500
RoHS COMPLIANT
ANIMAL FREE
USP CLASS VI
COLOR: NATURAL

2 ALL DIMENSIONS ARE TYPICAL

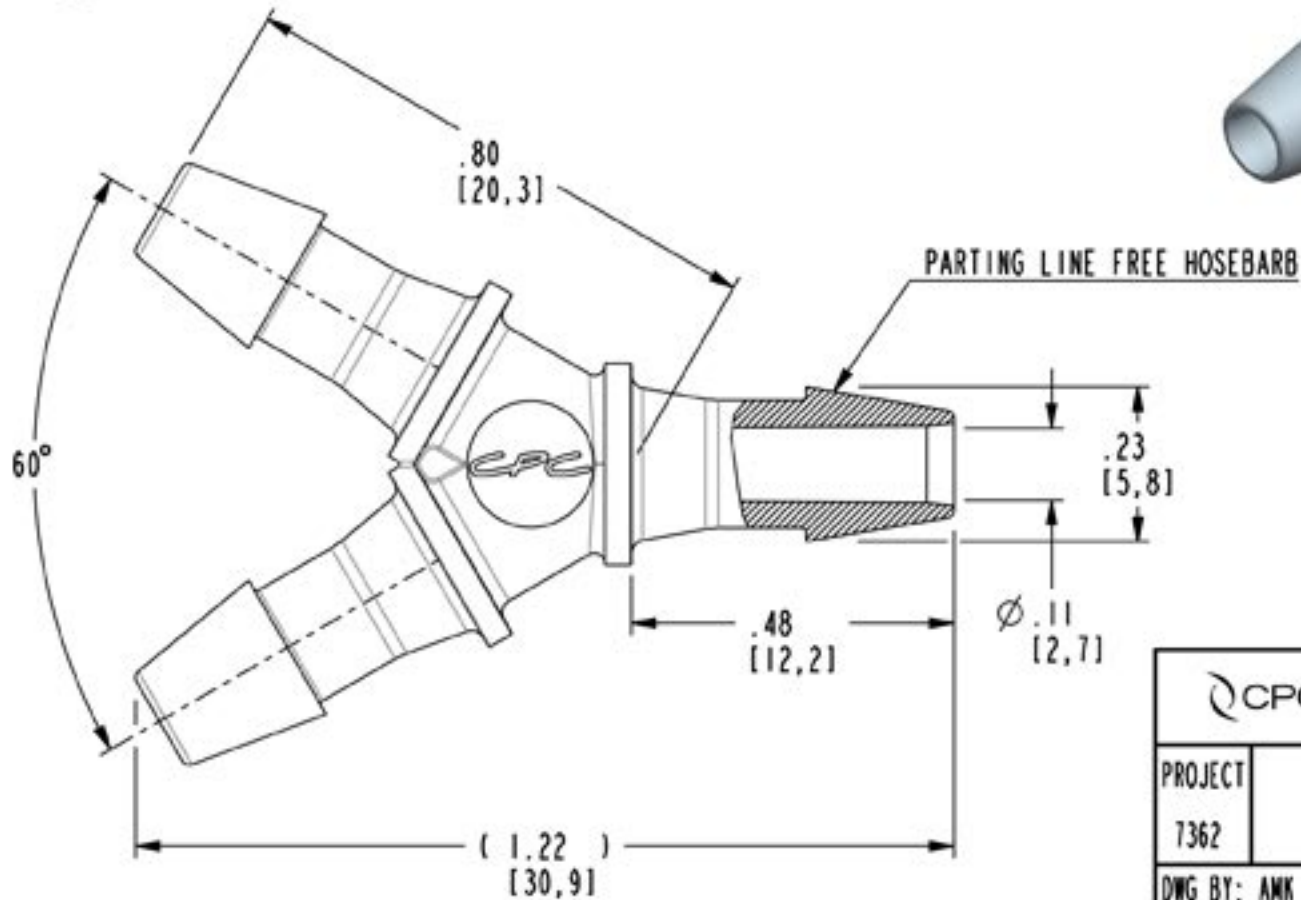

CPC 1 800 444 2474 cpcworldwide.com

PROJECT 5/32 HB Y-FITTING
7362 (CUSTOMER DRAWING)

DWG BY: AMK DATE: 06/30/09 CHKD BY:

MATL/FIN: SEE NOTE 1 DWG NO: HY5-CUST